

SMRT46

Megger Multi-Phase Relay Test System



- **Small, rugged, lightweight and powerful**
- **Operate with or without a computer**
- **Intuitive manual operation with Smart Touch View Interface**
- **High current, high power output (60 Amps/300 VA rms) per phase**
- **4 Voltage channels, 3 Current channels, with convertible voltage channels provides 1 voltage and 6 currents**
- **Dynamic, Transient and GPS Satellite Synchronized End-to-End Testing Capability**
- **IEC 61850 Testing Capability**

DESCRIPTION

The SMRT46 is a multipurpose, light-weight, field portable test set capable of testing a wide variety of electro-mechanical, solid-state and microprocessor-based protective relays, motor overload relays and similar protective devices. The SMRT46 has the "smart" combination of small size, light weight, with high power.

The SMRT46 test system has the ability to be manually controlled with Megger's Smart Touch View Interface™ (STVI) handheld controller running the new RTMS, Relay Testing Management Software. The STVI, with its large, full color, high resolution, TFT LCD touch screen allows the user to perform manual, steady-state and dynamic testing quickly and easily using the manual test screen, as well as using built-in preset test routines for most popular relays.

The STVI eliminates the need for a computer when testing virtually all types of relays. Menu screens and touch screen function buttons are provided to quickly and easily select the desired test function. Tests results can be saved to the STVI for download to a memory stick to transfer or print test reports.

For full automatic testing the SMRT46 may be controlled by Megger Advanced Visual Test Software (AVTS). AVTS is a Microsoft® Windows® XP@Service Pack 3/Vista™/7/8/10 compatible software program designed to manage all aspects of protective relay testing using the new Megger SMRT test system.

APPLICATIONS

The test system may be customized by adding the number of Voltage-Current, "VIGEN", modules needed for specific test applications, with a maximum of 3 channels. For example, the SMRT46 with three VIGEN Modules provides complete three-phase

testing of three-phase impedance, directional power, negative sequence overcurrent and other devices that require a three-phase four-wire wye connected sources. The 4th voltage channel provides an AC reference / synchronizing / polarizing voltage, or a DC battery simulator voltage source.

Each current channel is rated for 32 Amps @ 200 VA rms continuous, and up to 60 Amps @ 300 VA rms for short durations. For testing relay panels or electromechanical relays, it has a unique flat power curve from 4 to 32 Amps that insures maximum compliance voltage to the load at all times.

With a maximum compliance voltage of 50 Volts rms per phase, two channels in series provide 100 Volts to test high impedance relays. Three currents in parallel provide test currents up to 12 Amperes at 600 VA for testing ground overcurrent relays at high multiples of tap rating.

With three currents in parallel it can provide up to 180 Amps at 900 VA for testing all instantaneous overcurrent relays.

Each voltage channel can provide variable outputs of 0- 30/150/ 300 Volts at 150 VA of output power. Automatic range changing is done on-the-fly and under load. For testing a panel of relays or older electromechanical impedance relays, it has a unique flat power curve from 30 to 150 Volts insuring maximum output power to the load at all times.

With the VIGEN voltage channels converted to currents, a three channel unit can provide 6 currents for testing three phase current differential relays, including harmonic restraint transformer differential relays.

APPLICATIONS SELECTION GUIDE

Protective Relays by IEEE Device #		SMRT46 Single Channel	SMRT46 Two Channels	SMRT46 Three Channels
2	Time Delay	■	■	■
21	Distance Single Phase	■	■	■
21	Distance Three Phase Open Delta		■	■
21	Distance Three Phase Wye			■
24	Volts/Hz	■	■	■
25	Synchronizing		■	■
27/59	Under/Over Voltage	■	■	■
32	Directional Power Single Phase	■	■	■
32	Directional Power Three Phase (Open Delta)		■	■
37/76	DC Under/Over Voltage/Current	■	■	■
40	Loss of Field	■	■	■
46	Phase Balance Current	■	■	■
46N	Negative Sequence Overcurrent	■	■	■
47	Phase Sequence Voltage (Open Delta)		■	■
50	Instantaneous Overcurrent	Up to 75 Amps	Up to 150 Amps	Up to 225 Amps
51	Time Delay Overcurrent	Up to 35 Amps	Up to 70 Amps	Up to 105 Amps
55	Power Factor	■	■	■
60	Voltage/Current Balance (Open Delta)	Single Phase	■	■
67	Directional Overcurrent	■	■	■
67N	Ground Directional Overcurrent	■	■	■
78	Out of Step	■	■	■
79	Reclosing	■	■	■
81	Frequency	■	■	■
85	Carrier or Pilot Wire	■	■	■
87	Differential	■	■	■
91	Voltage Directional (Open Delta)		■	■
92	Voltage and Power Directional (Open Delta)		■	■
94	Tripping	■	■	■

SMRT46 RELAY TESTER

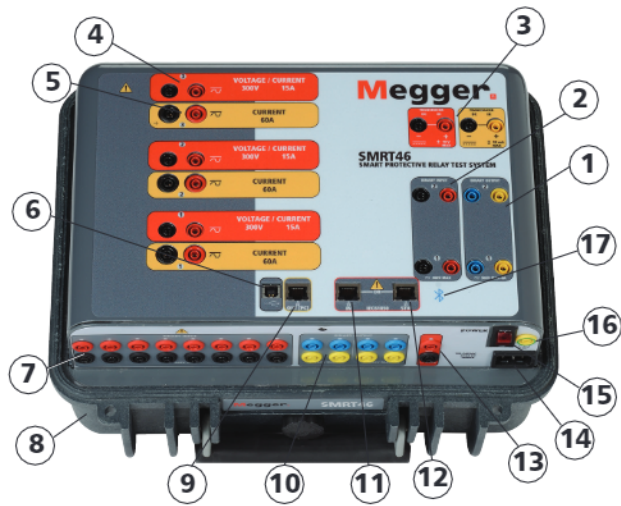

- Binary Outputs 1 and 2:** Rated for 300 V at 8 Amps.
- Binary Inputs 1 and 2:** Rated 5 to 300 V AC/DC.
- Transducer Input:** (Optional) DC voltage and DC milliamp input terminals.
- Voltage Outputs:** Up to 3 channels 300 V at 150 VA, convertible to currents 15 A at 120 VA per phase.
- Current Outputs:** Up to 3 channels 60 Amps at 300 VA per phase. Up 180 Amps at 900 VA single phase.
- USB 2.0 Interface:** Communication and control port.
- Additional Binary Inputs:** Provides 8 additional monitor circuits.
- Rugged Case:** Fiberglass reinforced plastic.
- PC/OUT:** Ethernet Port is the primary PC connection port. Ethernet Port used to chain multiple SMRT units together for synchronous multi-unit operation.
- Additional Binary Outputs:** Adds 4 outputs. Binary Outputs 3 and 4 are rated for 300 V AC/DC, 8 amperes. Binary Outputs 5 and 6 are high speed and have an AC/DC voltage rating of 400 volts peak, 1 ampere.
- IN:** Ethernet Port used to chain multiple SMRT units together for synchronous multi-unit operation. This port may also be used for connecting to the IEC 61850 substation bus for testing IEC 61850 devices.
- STVI:** Ethernet Port is a PoE (Power over Ethernet) port and is used to connect to the STVI for manual control.
- AC/DC Voltage Source:** Use as a 4th AC voltage source (0 -150 V at 100 VA) for synchronizing, or use as a variable DC voltage source (0 to 250 V at 100 Watts /3.33 amps) as a battery simulator.
- Incoming Power/Line Cord Socket:** 100 to 240 V, 50/60 Hz.
- POWER ON/OFF Switch:** Illuminates when power is on.
- Protective Earth Ground Jack.**
- Bluetooth:** Bluetooth® provides wireless control.

MANUAL OPERATION

The optional Smart Touch View Interface™ (STVI) touch screen allows the user to perform manual, steady-state and dynamic testing quickly and easily. Ergonomically designed with the control knob, and the touch screen, and the powerful RTMS software is extremely easy to use.



Figure 1 STVI with SMRT unit

The most significant feature of the RTMS software is its ability to provide the user with a very simple way to manually test, for both commissioning and maintenance, from the simple overcurrent relay to the most complex relays manufactured today. Manual operation is simplified through the use of a built-in computer operating system and the touch screen. The STVI controller and RTMS software eliminates the need for a computer when testing virtually all types of relays. Enhanced graphics, intuitive menu screens, and touch screen icon buttons are provided to quickly and easily select the desired test function.

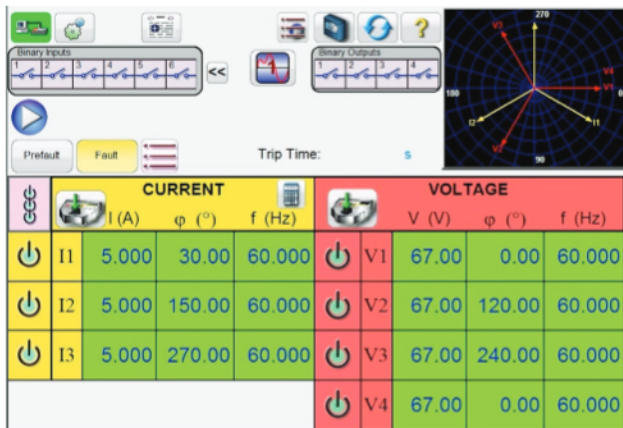

Figure 2 STVI Advanced User Interface

For more details on the RTMS software test capability see the RTMS datasheet.

FEATURES AND BENEFITS

Optional STVI Large Color TFT LCD touch-screen –

Easy to use and read (even in direct sunlight) display provides manual control of the test set. Color contrasts accentuate vital information. This reduces human error and time in testing relays.

Constant Power Output – The current amplifier delivers maximum compliance voltage to the load constantly during the test, and range changing is done automatically under load. This insures better test

results, and saves time by not having to turn the outputs off to change ranges. Constant power output in many cases eliminates the need to parallel and/or series current channels together to test high burden relays, which also saves time.

Higher Output Current – The SMRT46 provides up to 32 Amps at 200 VA per phase continuous, or up to 60 Amperes at 300 VA with a 1.5 second duty cycle. Three current amplifiers can be paralleled to provide a maximum of 180 Amperes at 900 VA for testing all instantaneous overcurrent relays.

PowerV™ Voltage Amplifier High Power Output – The SMRT46 provides a high VA output on the voltage channel at the lower critical test voltages (from 30 to 150 Volts). Users, who want to test a panel of relays at one time, or certain older electromechanical impedance relays, find it impossible using lower VA rated voltage sources.

STVI high resolution and accuracy – Metered outputs and timer provides extremely high accuracy. With metered outputs, what you see is what you get.

RTMS graphics and intuitive navigation – New test graphics and intuitive screen navigation saves test time and reduces human error.

STVI Internal memory – Provides storage of test set-up screens and test reports, which reduces testing time and paper work.

Steady-State and Dynamic test capability – The SMRT46 provides, either through manual control or computer control, both steady-state and dynamic testing of protective relays. This includes programmable waveforms with dc offset and harmonics.

Digital inputs and outputs – Up to 10 programmable inputs, and 6 programmable outputs provide timing and logic operations in real-time with the output voltage and currents. Binary Inputs can be programmed, using Boolean logic, for more complex power system simulations. This provides a low cost, closed loop, power system simulator.

Circuit breaker simulator – Binary outputs provide programmable normally closed and normally open contacts to simulate circuit breaker operation for testing reclosing relays. Sequence of operation, timing, and lockout are easily tested.

Performs transient tests –The SMRT46 can perform acceptance or troubleshooting tests by replaying digitally recorded faults, or EMTF/ATP simulations, in the IEEE- C37.111, COMTRADE Standard format.

Perform End-to-End tests – Using AVTSTM software Dynamic Control, or the RTMS Sequencer Test; with a portable GPS satellite receiver (or suitable IRIG-B time code source input into Binary Input #1), the SMRT46 performs satellite-synchronized end-to-end tests.

Perform Multi-Phase Tests – The SMRT46 can be interconnected with the SMRT1 single phase unit (or other SMRT units) to increase the total number of test currents for testing multi-phase bus differential protection schemes. For example, a 3 channel SMRT46 may be interconnected with 4 more SMRT46 units, providing up to a maximum of 30 current channels.

Three Ethernet ports – PC/61850 Ethernet Port is the primary PC connection port. The Ethernet port provides a high-speed computer interface, and may be used to connect to the IEC 61850 substation bus. The OUT Ethernet Port is primarily used to interconnect multiple SMRT units together for synchronous multi-unit operation. The STVI PoE (Power over Ethernet) port and is used to connect to

the STVI.

Immediate error indication – Audible and visual alarms indicate when amplitude or waveforms of the outputs are in error due to short circuit, open circuit, or thermal overload.

Open communication architecture – Use with third party software for more flexible automated control.

SPECIFICATIONS¹

Input Power

100 to 240 Volts AC, 1Ø, 47/63 Hz, 1800 VA.

Outputs

All outputs are independent from sudden changes in line voltage and frequency. All outputs are regulated so changes in load impedance do not affect the output. Each output (VIGEN) module consists of one voltage amplifier, and a current amplifier. The voltage amplifier may be converted to a current source. Therefore, one amplifier module may be used to test single phase current differential relays, including harmonic restraint.

Output Current Sources

The SMRT46 with three VIGEN modules can provide up to six current sources; three high current/high power, and three convertible voltage channels providing lower current/high power. The per channel output current and power ratings are specified in AC rms values and peak power ratings.

Per Channel Output

Output Current	Power	Max V
1 Ampere	15 VA	15.0 Vrms
4 Amperes	200 VA(282 peak)	50.0 Vrms
15 Amperes	200 VA(282 peak)	13.4 Vrms
32 Amperes	200 VA(282 peak)	6.67 Vrms
60 Amperes	300 VA(424 peak)	5.00 Vrms
DC	200 Watts	

Duty Cycle: 32 Amps Continuous, 60 Amps 1.5 seconds

Three Currents in Parallel:

Output Current	Power	Max V
12 Ampere	600 VA(848 peak)	50.0 Vrms
50 Amperes	600 VA(848 peak)	13.4 Vrms
96 Amperes	600 VA(848 peak)	6.67 Vrms
180 Amperes	900 VA(1272 peak)	5.00 Vrms

Two Currents in Series

With two currents in series, the compliance voltage doubles to provide from 4 A at 100 Vrms up to 32 A at 13 Vrms.

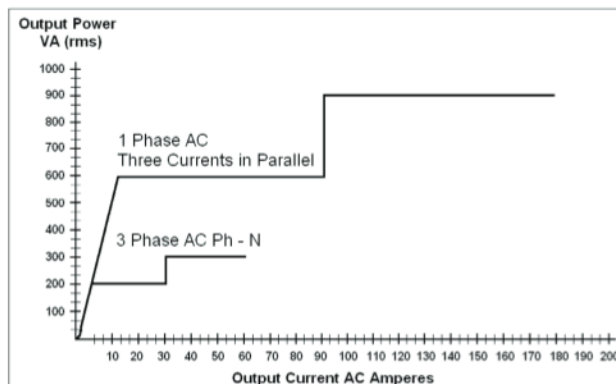

Figure 3 Current Output Power Curve

Current Amplifier - Extended Power Range:

The SMRT46 current amplifier provides a unique flat power curve from 4 to 32 Amperes per phase to permit testing of electromechanical high impedance relays, and other high burden applications, with an extended operating range up to 60 Amperes at 300 VA rms for short durations.

AC Voltage Output

The SMRT46 can provide three voltage sources 0 – 300 Volts AC/DC. The unit can provide a 4th AC/DC voltage source to serve as either a reference synchronizing voltage or as a battery simulator, see AC/DC AUX below.

Outputs are rated with the following Ranges:

Output Volts	Power	Max I
30 Volts	150 VA	5 Amps
150 Volts	150 VA	Variable ²
300 Volts	150 VA	0.5 Amps
DC	150 Watts	

Duty Cycle: Continuous

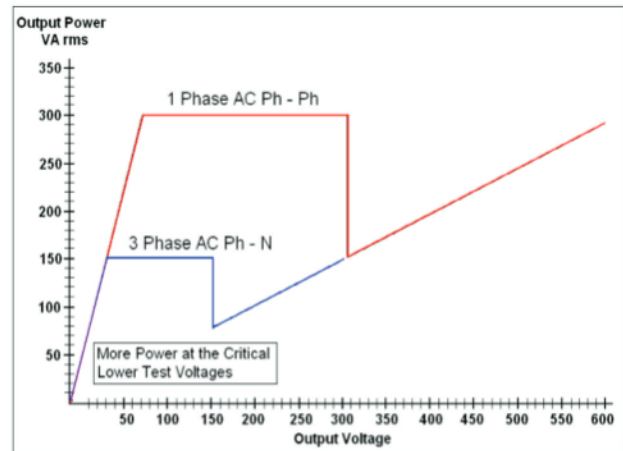

Figure 4 Voltage Output Power Curve

“PowerV™” Voltage Amp-Extended Power Range

The SMRT46 voltage amplifier provides a flat power curve from 30 to 150 Volts in the 150V range to permit testing of high current applications such as panel testing, and older electromechanical distance relays which demand a higher power voltage source to properly test.

Voltage Amplifier in Current Mode:

The voltage channels are convertible to a current source with the following output capability. Output power ratings are specified in AC rms values and peak power ratings.

Output Current	Power	Max V
5 Amperes	150 VA(212 peak)	30.0 Vrms
15 Amperes	120 VA	8.0 Vrms

Duty Cycle: 5 Amps Continuous, 15 Amps 1.5 seconds

¹ Megger reserves the right to change product specifications at any time.

² PowerV™ voltage amplifier output current varies depending on the voltage setting on the 150 Volt range, see curve.

AC/DC AUX

The AC/DC AUX voltage channel can be either a variable AC voltage source to use as a polarizing or synchronizing voltage source, or a battery simulator with a variable DC output voltage.

Ranges(AC)	Power	Max I
30 Volts	100 VA	3.33 A
150 Volts	100 VA	0.67 A

Ranges(DC)	Power	Max I
30 Volts	100 Watts	3.33 A
250 Volts	100 Watts	0.4 A

Phase Angle

Ranges 0.00 to 359.99 degrees, Counter Clock Wise, or Clock Wise rotation, or 0.00 to ± 180.00 degrees

Accuracy: $\pm 0.02^\circ$ typical, $\pm 0.25^\circ$ max at 50/60 Hz

Frequency

The output modules provide a variable frequency output with the following ranges and accuracy.

Ranges

DC

0.001 to 1000.000 Hz

Output amplifiers can provide transient signals with a range of DC to 10 kHz for transient playback using IEEE-C37.111 Standard COMTRADE files.

Resolution: 0.001 Hz

Frequency Accuracy: 2.5 ppm typical

25 ppm, 0° to 50° C, at 50/60 Hz Maximum

AC/DC AUX: 250 ppm, 50/60 Hz Maximum

Metering

Measured output quantities such as AC Amperes, AC Volts, DC Volts or DC Amperes, and Time may be simultaneously displayed on the touch screen. Preset AC and DC outputs display the approximate voltage/current output prior to initiation. This provides a fast, easy method for preset of outputs. Other values that may be displayed, depending on which test screen is in view, are phase angle, frequency, Ohms, Watts, VA, and Power Factor. Accuracies are specified from 10 to 100 % of range, $25^\circ\text{C} \pm 5^\circ\text{C}$, 50-60 Hz.

AC Voltage Amplitude

Accuracy: ± 0.05 % reading + 0.02 % range typical, ± 0.15 % reading + 0.05 % range maximum

Resolution: .01

Measurements: AC RMS

Ranges: 30, 150, 300V

AC Current Amplitude

Accuracy: ± 0.05 % reading + 0.02 % range typical, ± 0.15 % reading + 0.05 % range maximum

Resolution: .001/.01

Measurements: AC RMS

Ranges: 32, 60A

DC Voltage Amplitude

Accuracy: 0.1% range typical, 0.25% range maximum

Resolution: .01

Measurements: RMS

Ranges: 30, 150, 300V

DC Current Amplitude

Accuracy: ± 0.05 % reading + 0.02 % range typical, ± 0.15 % reading + 0.05 % range maximum

Resolution: .001/.01

Measurements: RMS

Ranges: 32A

Convertible Source in AC Current Mode

Accuracy: ± 0.05 % reading + 0.02 % range typical, ± 0.15 % reading + 0.05 % range or ± 12.5 mA whichever is greater

Resolution: .001

Measurements: AC RMS

Ranges: 5, 15A

AC/DC AUX Voltage Channel

AC Accuracy: ± 0.05 % reading + 0.02 % range typical, ± 0.15 % reading + 0.05 % range

DC Accuracy: 0.1% range typical, 0.25% range maximum

Resolution: .01

Measurements: RMS

Ranges: 30, 150 AC/DC, 250 DC

Total Harmonic Distortion

Less than 0.1% typical, 2% maximum at 50/60 Hz

Timer

The Timer-Monitor Input is designed to monitor and time-tag inputs, like a sequence of events recorder. In addition, the binary input controls enable the user to perform logic AND/OR functions, and conditionally control the binary output relay to simulate circuit breaker, trip, reclose and carrier control operation in real-time. The Timer function displays in Seconds or Cycles, with the following range and resolution:

Seconds: 0.0001 to 99999.9

(Auto Ranging)

Cycles: 0.01 to 99999.9

(Auto Ranging)

Accuracy: $\pm 0.001\%$ of reading, typical. ± 2 least significant digit, $\pm 0.005\%$ of reading from 0 to 50° C maximum

Binary Input

Start/Stop/Monitor Gate up to 10 inputs monitor operation of relay contacts or trip SCR, continuity light is provided for the input gate. Upon sensing continuity the lamp will glow. In addition to serving as wet/dry contacts the Binary Inputs may be programmed to trigger binary output sequence(s).

Input Rating: up to 300 V AC/DC

Binary Output Relays

SMRT46 has up to 6 independent, galvanically isolated, output relay contacts to accurately simulate relay or power system inputs to completely test relays removed from the power system. The binary output simulates normally open, or normally closed, contacts for testing breaker failure schemes. The binary output can be configured to change state based on binary input logic.

High Current Output Relays 1 to 4:

AC Rating: 400 V max., I_{max} : 8 amps, 2000 VA max.

DC Rating: 300 V max., I_{max} : 8 amps, 80 W

Response Time: <10ms

High Speed Output Relays 5 and 6:

AC/DC Rating: 400 V peak, I_{max} : 1 amp

Response Time: <1ms typical

Waveform Storage

Each output channel can store waveforms for playback on command. End-to-end playback of stored waveforms is possible, when triggered externally by a GPS receiver. Each channel can store up to 256,000 samples.

Protection

Voltage outputs are protected from short circuits and prolonged overloads. Current outputs are protected against open circuits and overloads.

DC IN Inputs (Optional Transducer Feature)**DC IN Volts**

Range: 0 to ± 10 V DC

Accuracy: $\pm 0.001\%$ reading + 0.005% range Typical
 $\pm 0.003\%$ reading + 0.02% range Max

Resolution: .001

Measurements: Average

DC IN Amperes

Ranges: 0 to ± 1 mA DC

4 to ± 20 mA DC

Accuracy: $\pm 0.001\%$ reading + 0.005% range Typical
 $\pm 0.003\%$ reading + 0.02% range Max

Resolution: .001

Measurements: Average

Environmental

Operating Temperature: 32 to 122° F (0 to 50° C)

Storage Temperature: -40 to 158° F (-40 to 70° C)

Relative Humidity: 5 - 95% RH, Non-condensing

Conformance Standards

Safety: EN 61010-1

Shock: EN/IEC 60068-2-27

Vibration: EN/IEC 68-2-6

Transit Drop: ISTA 1A

Free Fall: EN/IEC 60068-2-32

Drop / Topple: EN/IEC 60068-2-31

Electromagnetic Compatibility

Emissions: EN 61326-2-1, EN 61000-3-2/3, FCC Subpart B of Part 15 Class A

Immunity: EN 61000-4-2/3/4/5/6/8/11

Weight

Weight varies depending on the number of output modules in the system. The weight below is for a three-phase test system.

29.35 lb. (13.2 kg)

Dimensions

13.25 W x 6.75 H x 10.75 D in.

337 W x 172 H x 273 D mm

Enclosure and Transit Cases

The unit comes mounted in a rugged fiberglass reinforced plastic enclosure for field portability. Optional hard-sided transit case is available. The robust design of the optional hard-sided transit case provides protection when transporting the unit over rugged terrain and long distances.

ORDERING INFORMATION

STYLE NUMBER IDENTIFICATION

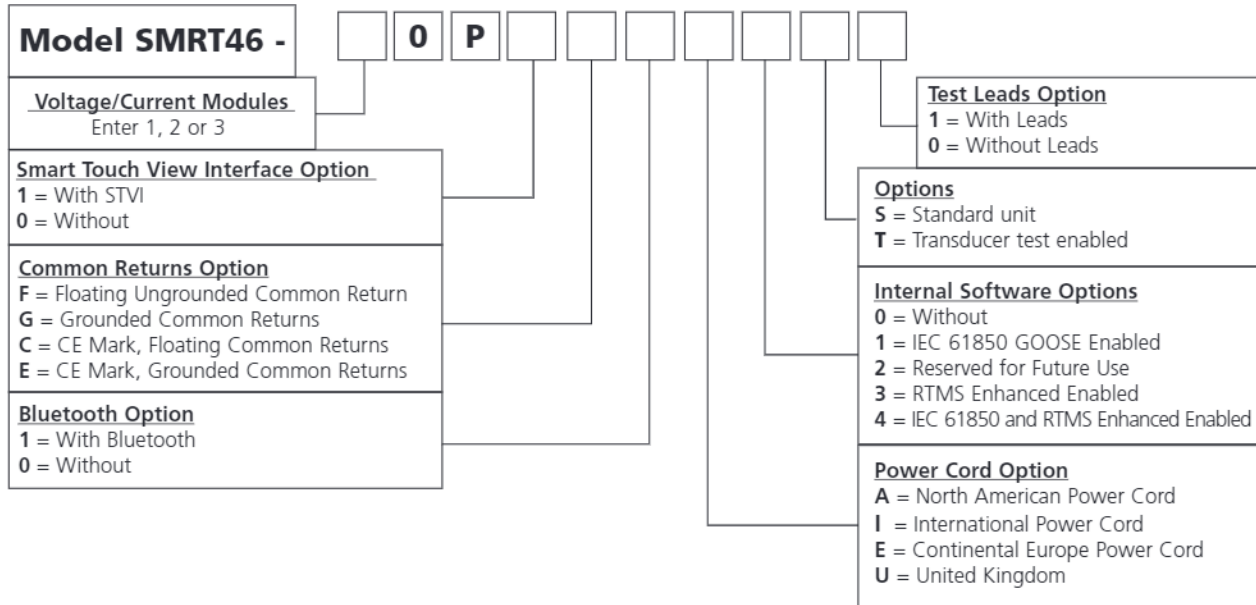

DESCRIPTIONS OF HARDWARE OPTIONS

This modular system lets you select the testing capabilities you need now and expand as testing requirements change. Customize the system by adding the number of Voltage-Current amplifier (VIGEN) modules (1, 2, or 3), selecting floating or grounded common returns, power cord, IEC 61850 test capable, and/or RTMS Enhanced software options, standard hardware or transducer feature added, and with or without test leads. See the following descriptions.

Voltage/Current Module: The SMRT46 unit can have 1, 2 or 3 voltage/current modules. Enter the number of desired modules **1, 2** or **3**.

Smart Touch View Interface Option: Enter the number **1** for the unit to come with the STVI hand-held controller, or enter the number **0** for without.

Common Returns Option: The floating returns option provides independent isolated return terminals for each output channel. The grounded common returns option, the return terminals are interconnected internally and connected to chassis ground. The CE Mark, C and E units, have been certified to the IEC standards for EMC for both the grounded and floating options. The F and G units are designed to operate in countries which do not require the CE mark.

Power Cord Option: Customers can choose which type of power cord they want the unit to come with.

- **A Option** – NEMA 5-15 to IEC60320 C13 connectors, UL & CSA approved for countries with NEMA outlets.
- **I Option** - International color-coded wires (light blue, brown and green with yellow stripe) insulation jacket stripped ready for male connector with IEC 60320 C13 connector. CE marked.
- **E Option** - CEE 7/7 "Schuko" plug to IEC 60320 C13 connector is CE marked.
- **U Option** - United Kingdom power cord with IEC 60320 C13 connector, and 13 Amp fuse. CE Marked.

Internal Software Options: The SMRT46 in conjunction with the optional Megger GOOSE Configurator (MGC) software can be used in the testing or commissioning of IEC 61850 compliant devices. In order for the SMRT46 to be able to subscribe as well as publish GOOSE messages, the IEC 61850 feature needs to be enabled. Enter the number **1** for the unit to come with the IEC 61850 option enabled. The number **2** is reserved for future use. Enter the number **3** to enable additional RTMS software features such as the Synchronizer and Frequency test. Enter the number **4** to have both IEC 61850 and RTMS software features enabled. Enter **0** for the unit without internal enhanced software options enabled.

Hardware Options: **S** =Standard unit. **T** = With Transducer test capability enabled (requires 3 channel configuration).

Test Leads Option: Enter the number **1** for the unit to come with Test Leads. Enter **0** for the unit without Test Leads.

DESCRIPTION OF SOFTWARE OPTIONS

#	Included Software	Part Number
1	AVTS Basic with RTMS Application Software	84978
	Optional Software	
1	AVTS Basic with IEC 61850 Megger GOOSE Configurator, and RTMS Application Software	1002-103
2	AVTS Advanced with RTMS Application Software	81570
3	AVTS Advanced Test with IEC 61850 Megger GOOSE Configurator, and RTMS Application Software	1001-106
4	AVTS Professional with RTMS Application Software	81571
5	AVTS Professional Test with IEC 61850 Megger GOOSE Configurator, and RTMS Application Software	1002-102

DESCRIPTIONS OF SOFTWARE

Included Software – Every unit comes with **AVTS Basic** and the PC version of the **RTMS software**

AVTS Basic with RTMS software (PC Version) Part No.: 84978

AVTS Basic includes Online Vector, Online Ramp and Online Click-On-Fault controls, with the ability to import, execute and save relay specific test modules. The easy to use online tools of Vector and Ramp provide automatic pickup, or dropout tests as well as timing and multi-state dynamic tests. The Online Click-On-Fault tool is used to automatically determine the reach characteristics of single or multi-zone Distance relays using shot for single point tests, or Ramp, Pulse Ramp, or Binary Search tools along user defined search lines. Basic also includes enhanced Relay Test Wizards for; Overcurrent, Differential, Voltage, Frequency and Distance relays. AVTS Basic does not require a software license key to run.

The powerful RTMS software can be run directly from a PC providing both manual and automatic test capabilities. See the RTMS datasheet for more detailed descriptions of test features and capabilities.

Additional Optional Software

AVTS Advanced with RTMS software Part No.: 81570

AVTS Advanced includes all of the features of AVTS Basic in addition to the powerful Test Editor and test editor tools, which includes the Dynamic Control (with dynamic end-to-end test capability, and Recorder features) for developing sequential tests for virtually any function or measuring element within digital relays. In addition, it also includes Modbus communications for automatic download of settings, SS1 File Converter for ASPEN[®] and CAPE[®] dynamic test files, End-to-End DFR Playback test capability and basic programming Tools for creating and editing test modules. Software comes with a USB software license key to run on any PC. Test files created in Advanced Test can be used with any PC running AVTS Basic without a software license key.

AVTS Professional with RTMS software Part No.: 81571

Professional Test includes all of the features of AVTS Advanced Test version plus the following additional specialized test tools. The DFR Waveform Viewer and Playback tools are used for viewing and analyzing IEEE C37.111 COMTRADE Standard files from digital fault recorders and microprocessor based relays. The DFR Waveform Viewer includes tools to recreate the analog and digital channels for playback into protective relays for troubleshooting or evaluation. It includes the capability to extend the prefault data as well as start

the timer associated with the event to time relay operation. These playback test files can also be used in end-to-end tests to recreate the transient event and evaluate the protection scheme. Test files created in Professional can be used with Advanced Test and Basic. Also included is the One-Touch Test Editor Control Tool for fully automatic testing of microprocessor based relays using VB script files to automatically download relay settings, and automatically test all the measuring elements within the relay based upon those settings. The Waveform Digitizer feature is also included in the Professional Test version of AVTS. It provides tools to create digital time curves for virtually any electromechanical relay time curve (that do not fit a time curve algorithm). It can even be used for digitizing scanned waveforms from a light-beam chart recorder. Software comes with a USB software license key to run on any PC. Test files created in Professional Test can be used with any PC running AVTS Basic without a software license key.

IEC 61850 Megger GOOSE Configurator Software (See Table for Part Numbers)

The Megger GOOSE Configurator (MGC) provides easy to use tools for testing relays and substations using the IEC 61850 protocol. It is an optional software tool available with Basic, Advanced or Professional versions of AVTS Software; see Descriptions of Software Options above. The Configurator provides relay test engineers and technicians the capability to import parameters from configuration files in the Substation Configuration Language (SCL) format, and/or capture GOOSE messages directly from the substation bus. All imported SCL GOOSE messages will be unconfirmed messages. Only captured messages are confirmed messages due to the Capture feature of the MGC. Use the MGC Merge feature to compare imported SCL and captured GOOSE messages to verify all GOOSE messages needed to perform tests. Use them to configure the SMRT to subscribe to preselected GOOSE messages by assigning the data attributes to the appropriate binary inputs of the SMRT. Use the configurator to assign the appropriate binary outputs of the SMRT to publish GOOSE messages simulating circuit breaker status. After the appropriate assignments of binary inputs and outputs have been made, the test file can be saved for reuse. This provides both manual and automatic testing of the relay using either the STVI or AVTS software. Use standard test modules in AVTS to perform automatic tests. Use the Dynamic Control in AVTS Advanced or Professional to perform high speed trip and reclose tests, or use to perform interoperability high-speed shared I/O tests between multiple IED's. The MGC provides mappings of Boolean and Bit Strings and/or simulation of STRuct, Integer/Unsigned, Float and UTC datasets.

³ Requires the Optional Megger GOOSE Configurator software to program the unit to subscribe and publish GOOSE messages, see Software Options for part numbers and descriptions.

TEST LEADS AND ACCESSORIES







All units come with a power cord, an Ethernet communication cable, and instruction manual. All other accessories vary depending on the number of amplifier modules selected, see **Table of Accessories**.

Included Standard Accessories

Description	Part Number
Power Cord - Depending on the style number, the unit will come with one of the following,	
Line cord, North American	90015-267
Line cord, Continental Europe with CEE 7/7 Schuko Plug	90015-268
Line cord, International color-coded wire	90015-269
Line cord, United Kingdom	90015-270
Ethernet cable for interconnection to PC, 210cm (7 ft.) long (Qty. 1 ea.)	90003-684
Instruction manual USB memory stick	81757

Table of Accessories

Accessories are supplied with the selection of the Test Leads Option. With the Test Leads Option the number and type of leads varies depending on the number of channels ordered. Test Leads and Accessories can be ordered individually, see part numbers below.

	Descriptions of Optional Test Leads and Accessories	Test Leads Options	One (1) Voltage Current Module	Two (2) Voltage Current Modules	Three (3) Voltage Current Modules
	Accessory Carry Case: Use to carry power cord, Ethernet cable, Optional STVI and test leads.	Qty. 1 ea. Part No. 2001-487			
	Sleeved Pair of Test Leads: Sleeved Test Leads, one red, one black, 200 cm (78.7") long, 600 V, 32 Amperes CAT II.	Qty. 3 pr. Part No. 2008-539	Qty. 3 pr. Part No. 2008-539	Qty. 6 pr. Part No. 2008-539	Qty. 2 pr. Part No. 2008-539
	Cable/Spade Lug Adapter (Small): Small lug fit most new relay small terminal blocks. Lug adapter, red, 4.1 mm, rated up to 1000 V/ 20 Amps CAT II.	Qty. 3 ea. Part No. 684004	Qty. 3 ea. Part No. 684004	Qty. 6 ea. Part No. 684004	Qty. 12ea. Part No. 684004
	Lug adapter, black, 4.1 mm, rated up to 1000 V/ 20 Amps CAT II.	Qty. 3 ea. Part Number 684005	Qty. 3 ea. Part Number 684005	Qty. 6 ea. Part Number 684005	Qty. 12ea. Part Number 684005
	Jumper Lead: Jumper lead, black, 12.5 cm (5") long, use with voltage / current outputs, 600 V, 32 Amps CAT II.			Qty. 2 ea. Part Number 2001-573	Qty. 4 ea. Part Number 2001-573
	4x6 Sleeved Combination Voltage Leads with Retractable Shrouds: Keeps the test leads from getting entangled. Three common leads connect to the test set, which are interconnected down to one black common to connect to the relay under test. Sleeved Three Phase Test Leads, 200 cm (78.7") long, 600 V, 32 Amperes CAT II.				Qty. 1 ea. Part Number 2008-540
	6x6 Sleeved Combination Voltage Leads with Retractable Shrouds: Keeps the test leads from getting entangled. Three pairs of leads connect to the test set, with three pairs to connect to the relay under test. Sleeved Three Phase Test Leads, 200 cm (78.7") long, 600 V, 32 Amperes CAT II				Qty. 1 ea. Part Number 2008-541

Additional Optional Accessories (Not Included in the SMRT46 Optional Test Lead Accessories)

Additional Optional Test Leads and Accessories can be ordered individually, see description and part numbers below. The following accessories and part numbers are in quantities of 1 each. Order the appropriate number required.

Description	Part No.
Individual (non-sleeved) Test Leads: Excellent for widely separated individual terminal test connections.	
	
Test lead, red , use with voltage/current output, or binary I/O, 200 cm long (78.7") 600 V/32 Amps CAT II.	620143
Test Lead, black , use with voltage/current output, or binary I/O, 200 cm long (78.7") 600 V/32 Amps CAT II.	620144

Description	Part No.
Jumper Lead: Used to common returns together externally when paralleling current channels (not required when using the sleeved combination current leads 2001-396)	
	
Jumper lead, black, 12.5 cm (5") long, use with voltage / current outputs, 600 V, 32 Amps CAT II.	2001-573

Long Individual (Non-Sleeved) Test Leads: Excellent for widely separated individual terminal test connections.	
	
Extra long Lead, black , use with voltage/current output, or binary I/O, 360 cm long (12 ft) 600 V/ 32 Amps CAT II	2003-172
Extra long Lead, red , use with voltage/current output, or binary I/O, 360 cm long (12 ft) 600 V/ 32 Amps CAT II	2003-173

Flexible Test Lead Adapter: Use with rail-mounted terminals or screw clamp connections where spade lugs and crocodile/alligator clips cannot be used.	
	
Flexible test lead adapter, black, 1.8 mm male pin, use with test leads up to 1000 V/32 Amps CAT III.	90001-845

RLC, Relay Lead Connector: Excellent for easily connecting three phase voltage and current leads to the test system.	
	
Two sets of test leads (one for voltages and one for currents), sleeved, 4 mm (0.16 in.) terminals with retractable safety shrouds, color coded red, yellow, blue, black, 200 cm long (78.7") 600 V/ 32 Amps CAT II	RLC

Flexible Test Lead Adapter with Retractable Insulated Sleeve: Use for connection to old style non-safety sockets with retractable protective sleeve on one end.	
	
Retractable sleeve test lead, red , 50 cm (20") long, use with test leads up to 600 V/32 Amperes CAT II.	90024-781
Retractable sleeve test lead, black , 50 cm (20") long, use with test leads up to 600 V/32 Amperes CAT II.	90024-780

Cable/Spade Lug Adapter (Large): Large spade lug fits older relay terminal blocks, or STATES® Company FTP10 or FTP14 Test paddles, ABB or General Electric test plugs with screw down terminals.	
	
Lug adapter, red , 6.2 mm, use with test leads up to 1000 V/20 Amps CAT II.	684002
Lug adapter, black , 6.2 mm, use with test leads up to 1000 V/20 Amps CAT II.	684003

Parallel Test Lead Adapter: Used when paralleling up to three current test leads together to a common test point. Usually used when connecting to a test paddle or relay terminal.	
	
Parallel test lead adapter, use with test leads up to 600 V/ 32 Amps CAT II	1002-286

Alligator/Crocodile Clip: Excellent for test connections to terminal screws and pins where spade lugs cannot be used.	
	
Alligator clip, red , use with test leads up to 1000 V/32 Amps CAT III.	684006
Alligator clip, black , use with test leads up to 1000 V/32 Amps CAT III.	684007

STATES® Company 10 Pole Test Paddle: Use with STATES® FMS 10 Pole Test Switch or ABB FT-1 10 pole Test Switch.	
	

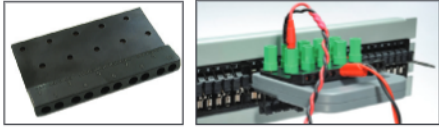
Description	Part No.
Test paddle features knobs which also serve as insulated Ø 4 mm rigid socket accepting spring loaded Ø 4 mm plugs with rigged insulating sleeve, or retractable sleeve. Use with test leads up to 600 V, 32 Amperes CATII.	V1TP10
STATES® 10 Pole Test Paddle Attachment: Use with STATES V1TP10 Test Paddle.	
	
Test paddle attachment provides an additional 10 insulated connection points for front connection, as well as the standard top connections for test leads. Adapter can provide convenient parallel test connections of test currents to two terminals at one time. Use with test leads up to 600 V, 32 Amperes CAT II.	TPA10

GPS unit with accessories	
	
GPS unit with all-weather antenna, power supply, and 15 meter cable	MGTR-II-50
GPS unit with all-weather antenna, power supply, and 30 meter cable	MGTR-II-100

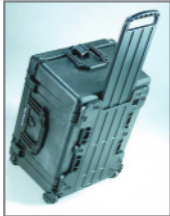
Hard-Sided Transit Case	
Includes custom designed foam inserts for the SMRT46 unit, and accessories. Transit case includes retractable handle, built-in wheels, and Lock-down latches, fold-down handles, with O-ring seal.	
	
Rugged, hard-sided transit case (1ea).	1007-921